

A photograph of a modern office lobby. The room features large windows with dark frames, providing a view of a green landscape. In the foreground, a dark, textured carpet mat is laid out on a light-colored floor. The walls are white, and there are several dark columns supporting the ceiling. The overall atmosphere is clean and professional.

ENTRANCE MATS
and accessories – German Quality

KAFLOOR
www.kafloor.de



Kafloor Mats GmbH

Kafloor Mats GmbH - entrance mat and floor mat expertise, all in one place.

Our manufacturing presence in Germany goes back more than 40 years. Right from the beginning, we have been delivering German brand quality expectations and tailor-made solutions to customers across the whole of Europe.

One of our greatest strengths is our extensive sales network.



Contents

Entrance mats for indoor areas

	Page
Portagard I + IS	8
Portagard IEB + ISEB	9
Portagard IB	10
Portagard IK	11
Portagard I3B + IS3B	12
Portagard DB + SDB	13
Portagard profile with lettering Portagard	14

Entrance mats for outdoor areas

	Page
Portagard A + AS	18
Portagard A3B + AS3B	19
Portagard AB	20
Portagard AK	21

Profileless entrance mats

	Page
Starcort/Kokomat	24
Universal	25

Accessories & service

	Page
Mat frames and accessories	28
Substructures and dirt collection wells	30
Planning, measuring up and laying	32
Maintenance	33
Contact	34
Order form	35

Explanation of symbols

MAT PROPERTIES



Suitable for indoor areas



Suitable for covered outdoor areas



Suitable for outdoor areas



Closed mat construction



Open mat construction



Low moisture absorption



Moderate moisture absorption



High moisture absorption



Rollable mat, flexible



3 year warranty



For normal foot traffic



For high foot traffic



For intensive foot traffic



Low dirt uptake



Moderate dirt uptake



High dirt uptake



Brush strips, single



Triple brushes



Scraper bar

ENTRANCE MATS
for indoor areas







PORTAGARD

Portagard I + IS (heavy-duty)

Properties



Colour options



Description

The open-construction roll-up mat for functionally demanding areas. With robust, ribbed carpet strips in an aluminium support chassis with sound insulation underlay and integral micro scraper profile.

Product variants

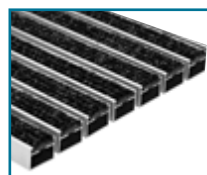

Portagard I, 12 mm
Height: 12 mm
Weight: 8.1 kg/m²

Portagard I, 17 mm
Height: 17 mm
Weight: 8.4 kg/m²

Portagard I, 22 mm
Height: 22 mm
Weight: 9.4 kg/m²

Portagard I, 27 mm
Height: 27 mm
Weight: 10.4 kg/m²

Dimensional drawing

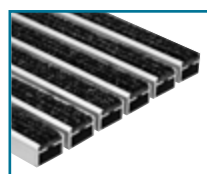
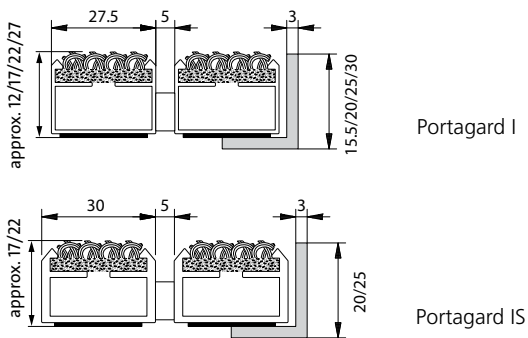

Portagard IS, 17 mm
reinforced aluminium profile
Height: 17 mm
Weight: 11.8 kg/m²

Portagard IS, 22 mm
reinforced aluminium profile
Height: 22 mm
Weight: 14.5 kg/m²

Product features

- » Material: aluminium
- » Profile spacing: 5 mm
- » Can be driven over by wheelchairs and handtrolleys
- » Type IS can also be driven over by heavier vehicles
- » Suitable for continuous loading
- » Insert also available in Cfl-S1
- » Manufactured to any required size

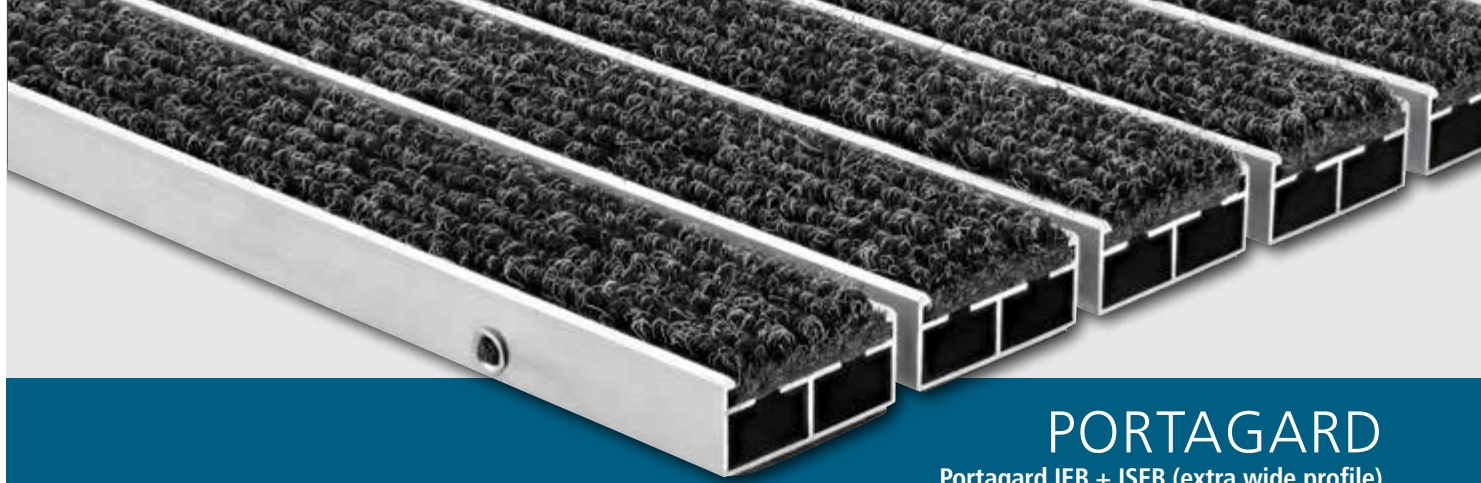

PORTAGARD

Portagard IEB + ISEB (extra wide profile)

Properties



Colour options



Description

Due to their extra wide profiles, Portagard IEB and ISEB can collect extremely high levels of moisture and dirt and combine a high-quality appearance with high load capacity.

Product variants

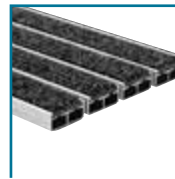

Portagard IEB
Height: 22 mm
Weight: 9.0 kg/m²

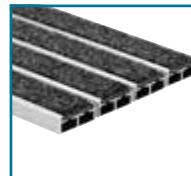

Portagard ISEB
reinforced aluminium profile
Height: 22 mm
Weight: 13.3 kg/m²

Dimensional drawings

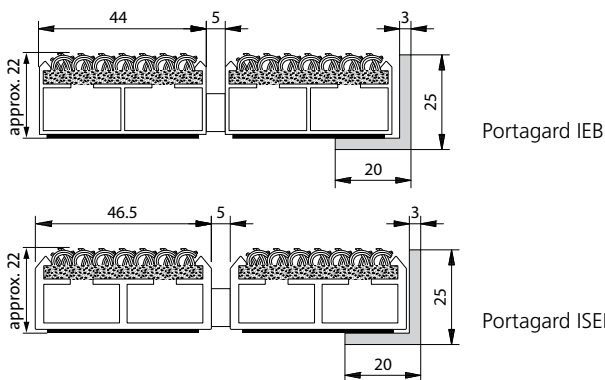

Product features

- » Material: aluminium, reinforced profile on type ISEB
- » Wiper strips: ribbed carpet, coloured
- » Profile spacing: 5 mm
- » Type IEB can be driven over by wheelchairs and handtrolleys
- » Type ISEB can also be driven over by heavier vehicles
- » Type IEB suitable for continuous loading
- » Type ISEB suitable for extreme continuous loading
- » Insert also available in Cfl-S1
- » Manufactured to any required size

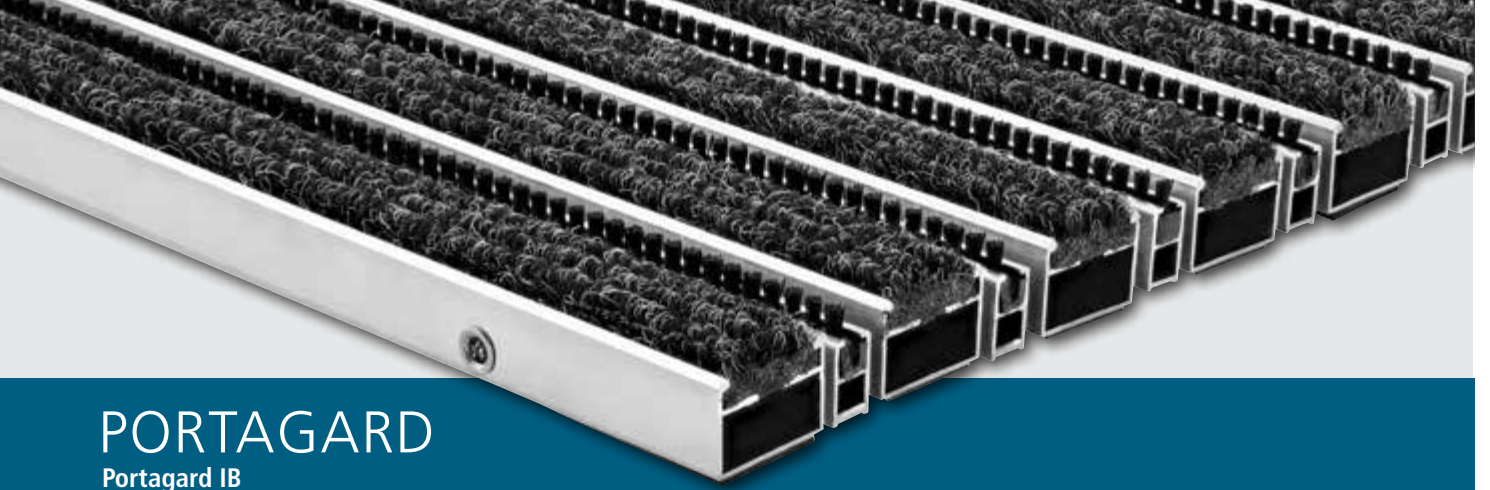

PORTAGARD

Portagard IB

Properties

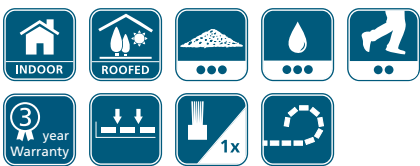

Colour options

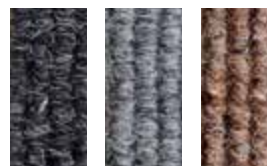

anthracite light grey beige

Description

Due to its integral brush strips, Portagard IB can be used where there are excessive levels of dirt and moisture. Its ribbed carpet strips retain their robust performance, even under high load.

Product variants



Portagard IB, 17 mm

brush strips: black
Height: 17 mm
Weight: 10.6 kg/m²

Portagard IB, 22 mm

brush strips: black
Height: 22 mm
Weight: 11.9 kg/m²

Dimensional drawing

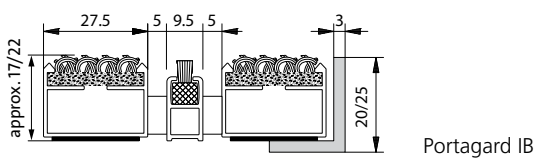

Portagard IB

Product features

- » Material: aluminium
- » Wiper strips: ribbed carpet, coloured
- » Brush strips, black
- » Profile spacing: 5 mm
- » Can be driven over by wheelchairs and handtrolleys
- » Suitable for continuous loading
- » Ribbed carpet insert also available in Cfl-S1
- » Manufactured to any required size

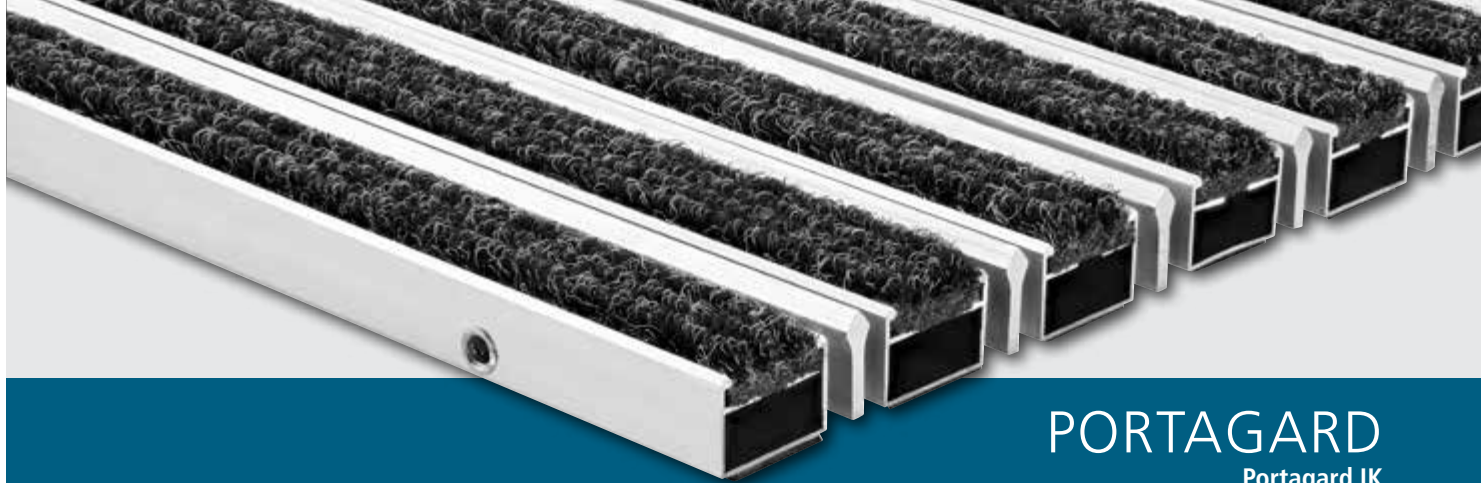

PORTAGARD

Portagard IK

Properties



Colour options



Description

The open-construction roll-up mat for functionally demanding areas. Made from replaceable, robust ribbed carpet strips in an aluminium support chassis with additional aluminium scraper profile to collect coarse dirt.

Product variants



Portagard IK, 17 mm
Height: 17 mm
Weight: 10.5 kg/m²

Portagard IK, 22 mm
Height: 22 mm
Weight: 12.0 kg/m²

Dimensional drawing

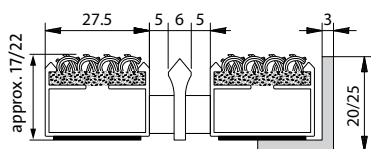

Portagard IK

Product features

- » Material: aluminium
- » Wiper strips: ribbed carpet, coloured
- » Aluminium scraper profile
- » Profile spacing: 5 mm
- » Can be driven over by wheelchairs and handtrolleys
- » Suitable for continuous loading
- » Insert also available in Cfl-S1
- » Manufactured to any required size

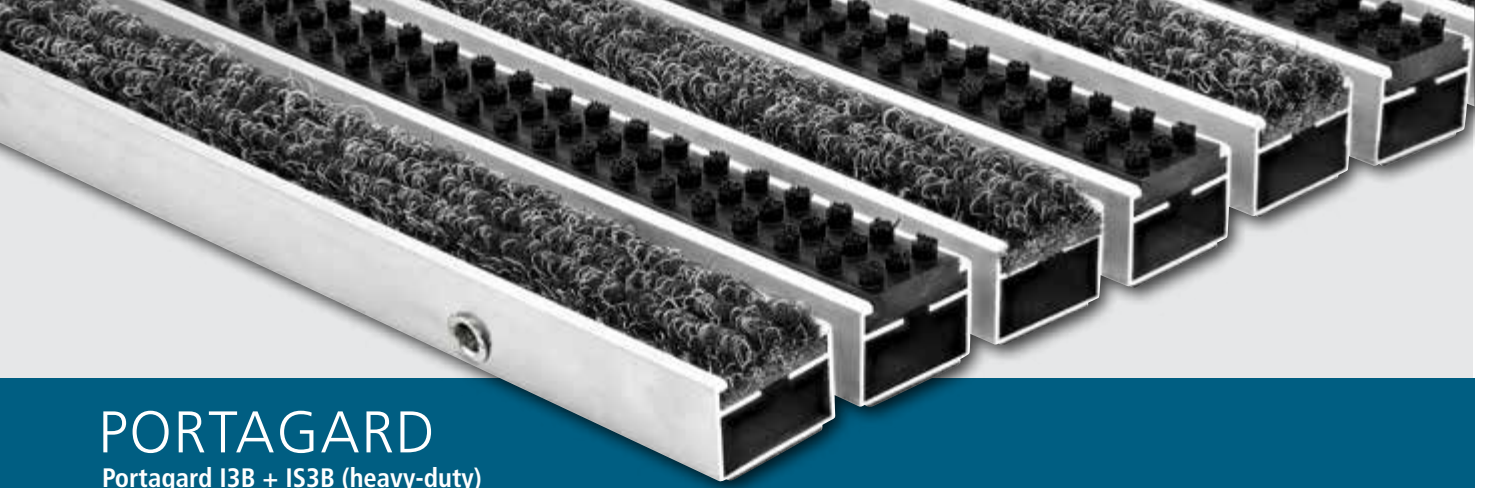

PORTAGARD

Portagard I3B + IS3B (heavy-duty)

Properties



Colour options



Description

With their triple brush strips, Portagard I3B and Portagard IS3B are used in areas with particularly high levels of dirt and moisture.

Product variants

Dimensional drawing

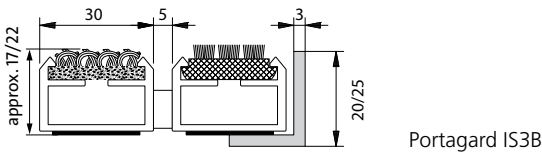
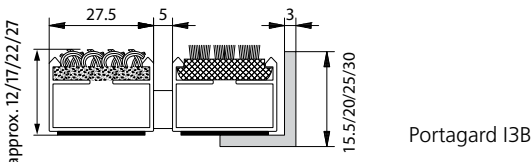

Portagard I3B, 12 mm

Height: 12 mm
Weight: 10.7 kg/m²

Portagard I3B, 17 mm

Height: 17 mm
Weight: 11 kg/m²

Portagard I3B, 22 mm

Height: 22 mm
Weight: 12.1 kg/m²

Portagard I3B, 27 mm

Height: 27 mm
Weight: 13.1 kg/m²

Product features

- » Material: aluminium
- » Wiper strips: ribbed carpet, coloured / triple brushes, black or grey
- » Profile spacing: 5 mm
- » Type I3B can be driven over by wheelchairs and handtrolleys
- » Type IS3B can be driven over by heavier vehicles
- » Suitable for continuous loading
- » Ribbed carpet insert also available in Cfl-S1
- » Manufactured to any required size

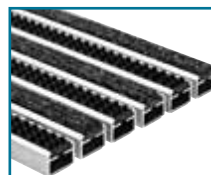

Portagard IS3B, 17 mm

reinforced aluminium profile
Height: 17 mm
Weight: 14.3 kg/m²

Portagard IS3B, 22 mm

reinforced aluminium profile
Height: 22 mm
Weight: 16.9 kg/m²

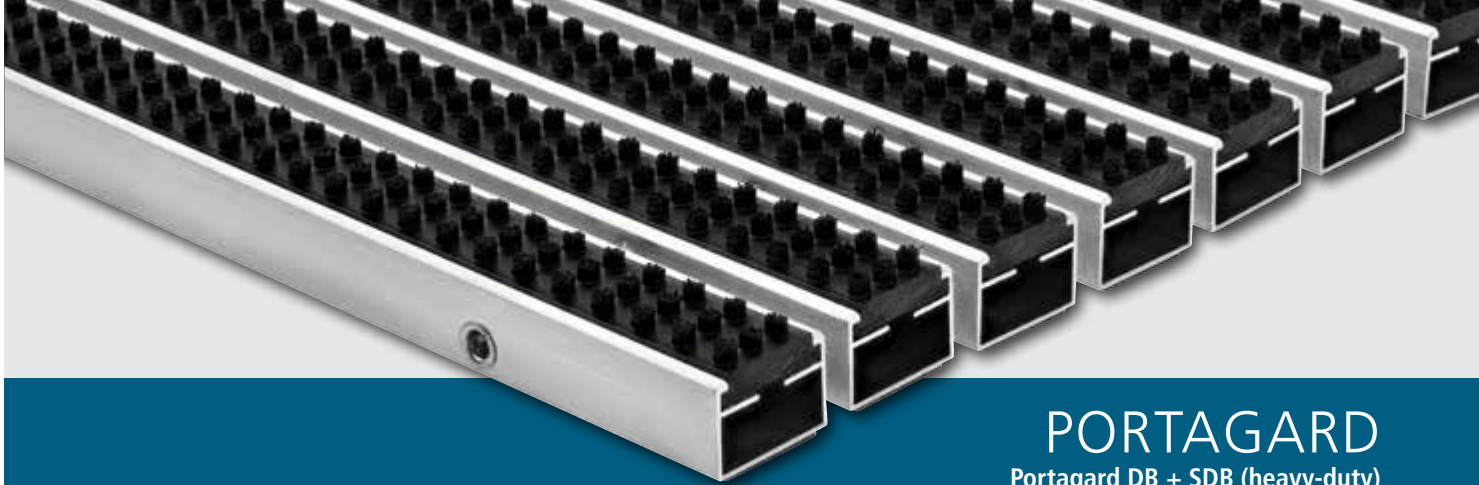

PORTAGARD

Portagard DB + SDB (heavy-duty)

Properties

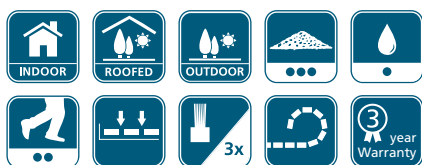

Colour options



black brushes grey brushes

Description

With their triple brush strips, Portagard DB and Portagard SDB are used in areas with particularly high levels of dirt and coarse dirt.

Dimensional drawing

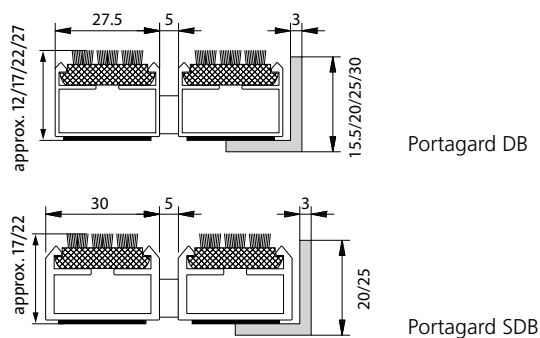

Product variants

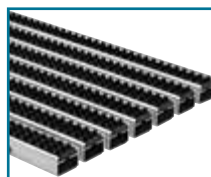

Portagard DB, 12 mm
Height: 12 mm
Weight: 14.1 kg/m²

Portagard DB, 17 mm
Height: 17 mm
Weight: 14.4 kg/m²

Portagard DB, 22 mm
Height: 22 mm
Weight: 15.5 kg/m²

Portagard DB, 27 mm
Height: 27 mm
Weight: 15.9 kg/m²

Product features

- » Material: aluminium
- » Triple brushes, black or grey
- » Profile spacing: 5 mm
- » Type DB can be driven over by wheelchairs and handtrolleys
- » Type SDB can be driven over by heavier vehicles
- » Suitable for continuous loading
- » Manufactured to any required size

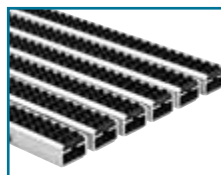

Portagard SDB, 17 mm
reinforced aluminium profile
Height: 17.2 mm
Weight: 16.7 kg/m²

Portagard SDB, 22 mm
reinforced aluminium profile
Height: 22 mm
Weight: 20.1 kg/m²



PROFILE WITH LETTERING

for Portagard

Properties



Description

Give your building a personal, individual and unique touch, right at the point of entry, by combining the Kafloor profile with lettering with the proven Kafloor Portagard mat system (construction height 12, 17, 22 or 27 mm).

It lifts the whole entrance area with its simple, yet high-quality air of elegance.

The stainless steel profile with its laser-cut lettering 'WELCOME' is incorporated into the mat system exactly how you want it.

Product features

- » Stainless steel U-shaped profile
- » Laser-cut lettering
- » No additional fitting costs
- » Modern design for the entrance area
- » A quality and stylish eye-catcher

Colour options



Profile: stainless steel; lettering: black

Product variants



Profile with lettering for entrance mats, 12 mm
for Portagard 12 mm
Profile width: 51 mm
Material thickness: 1.5 mm



Profile with lettering for entrance mats, 17 mm
for Portagard 17 mm
Profile width: 51 mm
Material thickness: 1.5 mm



Profile with lettering for entrance mats, 22 mm
for Portagard 22 mm
Profile width: 51 mm
Material thickness: 1.5 mm



Profile with lettering for entrance mats, 27 mm
for Portagard 27 mm
Profile width: 51 mm
Material thickness: 1.5 mm

AVC Evolis

ENTRANCE MATS
for outdoor areas





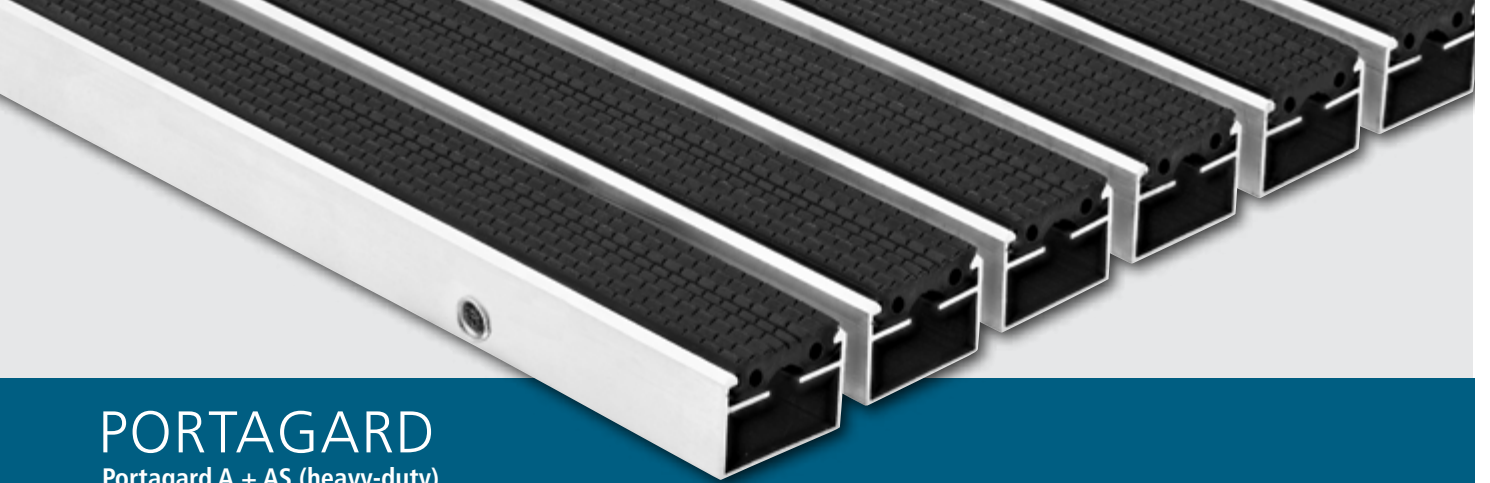

PORTAGARD

Portagard A + AS (heavy-duty)

Properties



Colour options

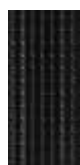

black rubber

Description

Portagard A is a highly flexible entrance mat design. Available in four different heights, it is a reliable solution for an extremely wide range of applications. It also has an integral micro-scrapers profile.

Product variants

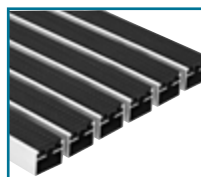

Portagard A, 12 mm
Height: 12 mm
Weight: 12.7 kg/m²

Portagard A, 17 mm
Height: 17 mm
Weight: 13.0 kg/m²

Portagard A, 22 mm
Height: 22 mm
Weight: 14.1 kg/m²

Portagard A, 27 mm
Height: 27 mm
Weight: 14.5 kg/m²

Dimensional drawing

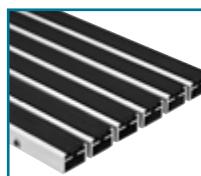
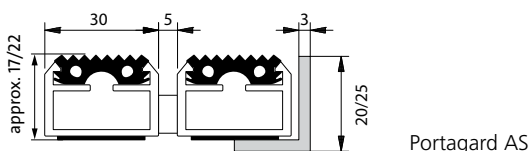
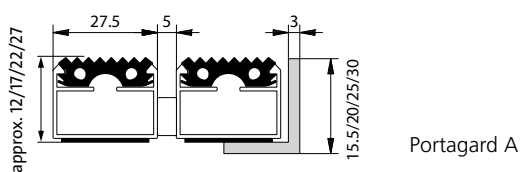

Portagard AS, 17 mm
reinforced aluminium profile
Height: 17 mm
Weight: 16.0 kg/m²

Portagard AS, 22 mm
reinforced aluminium profile
Height: 22 mm
Weight: 18.8 kg/m²

Product features

- » Material: aluminium
- » Wiper strips: rubber, black
- » Profile spacing: 5 mm
- » Type A can be driven over by wheelchairs and handtrolleys
- » Type AS can be driven over by heavier vehicles
- » Type A suitable for continuous loading
- » Type AS suitable for extreme continuous loading
- » Manufactured to any required size

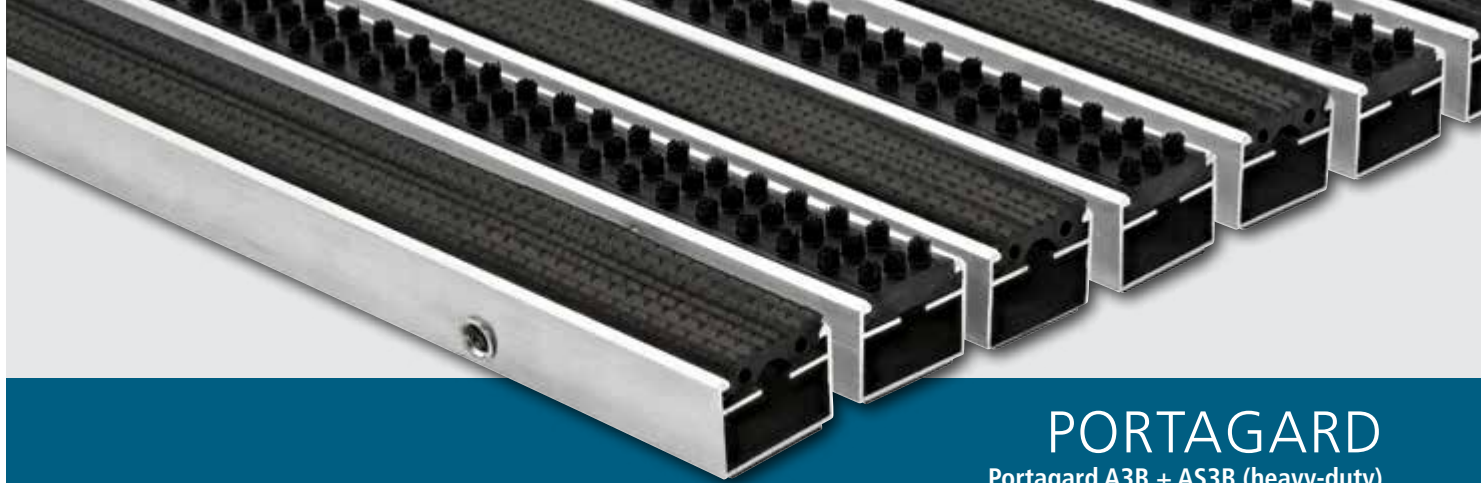

PORTAGARD

Portagard A3B + AS3B (heavy-duty)

Properties

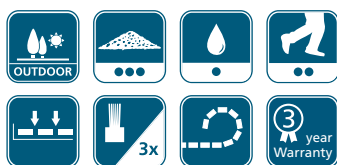

Colour options

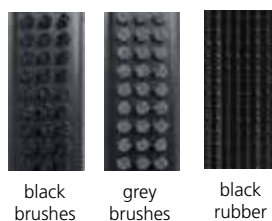

Description

Portagard A3B is the best option in areas with extremely high levels of coarse dirt. Its triple brushes and micro-scraper profile in the rubber strips reliably collect even stubborn dirt.

Product variants

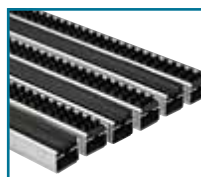

Portagard A3B, 12 mm
Height: 12 mm
Weight: 12.4 kg/m²

Portagard A3B, 17 mm
Height: 17 mm
Weight: 13.7 kg/m²

Portagard A3B, 22 mm
Height: 22 mm
Weight: 14.7 kg/m²

Portagard A3B, 27 mm
Height: 27 mm
Weight: 15.2 kg/m²

Dimensional drawing

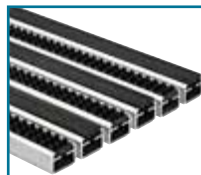
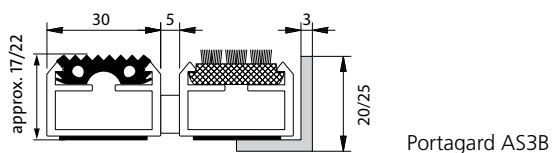
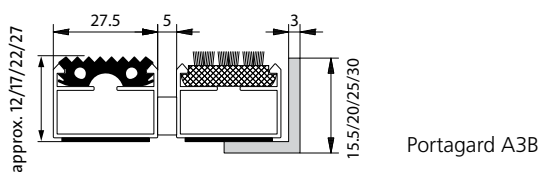

Portagard AS3B, 17 mm reinforced aluminium profile
Height: 17 mm
Weight: 16.6 kg/m²

Portagard AS3B, 22 mm reinforced aluminium profile
Height: 22 mm
Weight: 19.4 kg/m²

Product features

- » Material: aluminium
- » Wiper strips: rubber, black; triple brushes, black or grey
- » Profile spacing: 5 mm
- » Type A3B can be driven over by wheelchairs and handtrolleys
- » Type AS3B can be driven over by heavier vehicles
- » Suitable for continuous loading
- » Manufactured to any required size

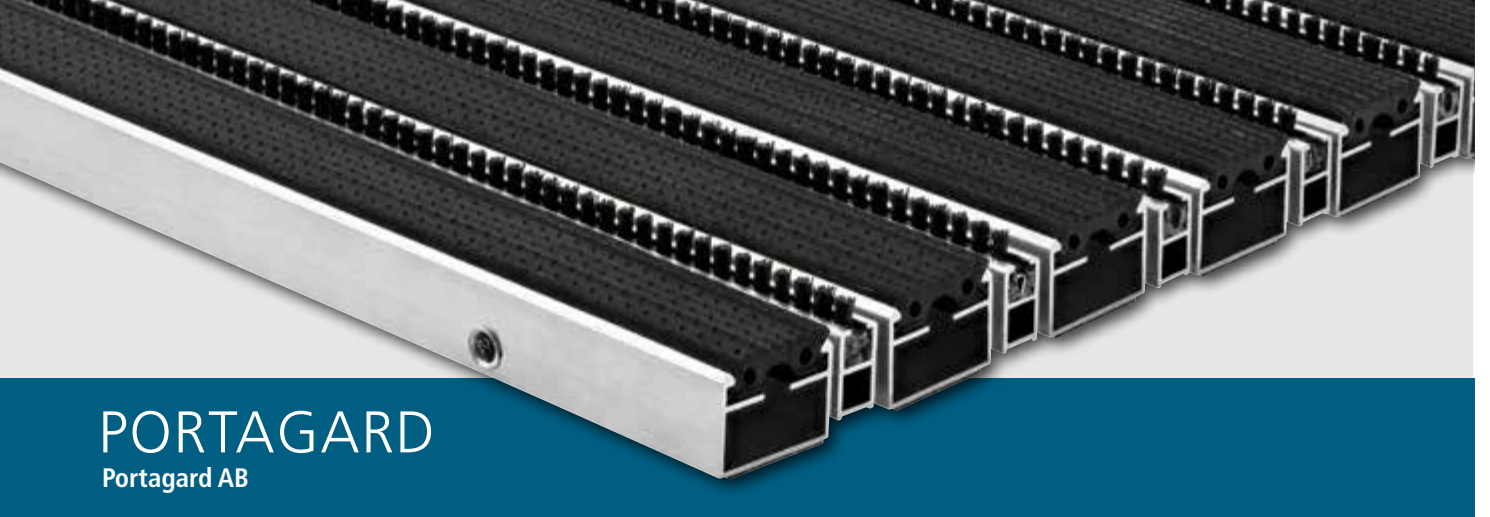

PORTAGARD

Portagard AB

Properties

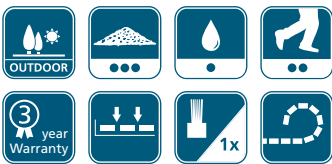

Colour options

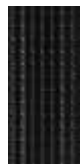

black rubber

Description

Due to its integral brush strips, Portagard AB can be used where there are high levels of dirt. The micro-scraper profile incorporated in the rubber strips also ensures reliable levels of cleanliness.

Product variants



Portagard AB, 17 mm
brush strips, black
Height: 17 mm
Weight: 14.2 kg/m²

Portagard AB, 22 mm
brush strips, black
Height: 22 mm
Weight: 15.4 kg/m²

Dimensional drawing

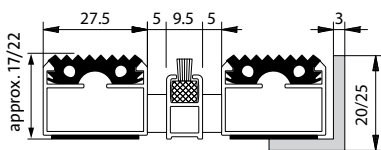

Portagard AB

Product features

- » Material: aluminium
- » Wiper strips: rubber, black
- » Brush strips, black
- » Profile spacing: 5 mm
- » Can be driven over by wheelchairs and handtrolleys
- » Suitable for continuous loading
- » Manufactured to any required size

PORTAGARD

Portagard AK

Properties

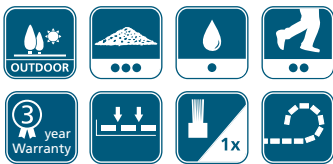

Colour options



black
rubber

Description

Due to its integral scraper profiles, Portagard AK can be used where there are high levels of dirt. The micro-scraper profile incorporated in the rubber strips also ensures reliable levels of cleanliness.

Product variants



Portagard AK, 17 mm

aluminium scraper profile
Height: 17 mm
Weight: 14.2 kg/m²

Portagard AK, 22 mm

aluminium scraper profile
Height: 22 mm
Weight: 15.5 kg/m²

Dimensional drawing

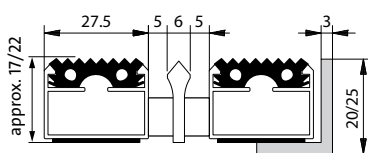

Portagard AK

Product features

- » Material: aluminium
- » Wiper strips: rubber, black
- » Aluminium scraper profile
- » Profile spacing: 5 mm
- » Can be driven over by wheelchairs and handtrolleys
- » Suitable for continuous loading
- » Manufactured to any required size

ENTRANCE MATS
WITHOUT PROFILE
for indoor and outdoor areas





STARCORT/KOKOMAT

Properties



Colour options



anthracite light grey beige brown black

Description

The Starcort and Kokomat mats are economical, robust and can be laid very quickly. Due to their high cleaning action, Starcort mats work well in combination with Portagard I mats.

Product variants

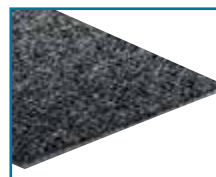

Starcort

Height: 10 mm
Material: polypropylene, rubber backing
Colours: anthracite, light grey, beige
Mat (cut length) max. approx. 350 x 200 cm (w/o border)

Product features

- » easy to lay without frames
- » easy to clean with a vacuum cleaner
- » low weight



Kokomat

Height: 17 mm, 20 mm
Material: natural coir fibres, vinyl backing
Colours: brown, black
Roll (cut length) max. approx. 200 cm wide
Mat - made to measure

KOKOMAT:

These mats are a natural product which is not 100% dimensionally stable. Due to the natural 'breathing' properties of the material, it can expand in damp conditions and shrink in low humidity atmospheres. Dimensional tolerances of up to 3% should be taken into consideration and do not represent a defect in the mat.



UNIVERSAL

rubber honeycomb mat

Properties



Description

Universal rubber honeycomb mats are the most versatile option in our range of entrance mats. They are suitable for both indoor and outdoor use and are perfect for areas with high moisture levels or as workstation mats in industrial or commercial applications.

Product features

- » Material: solid rubber, black, in honeycomb pattern
- » Drive-over capability
- » Tailor-made to specific dimensions

Product variants

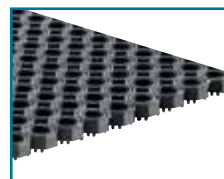

Universal open
honeycomb with open base
Height: 22 mm
Weight: 10 kg/m²



Connecting block
Material: rubber, black



Round brush
loose, black

ACCESSORIES & SERVICE







MAT FRAMES

and accessories

This section contains information on mat frames for the Kafloor entrance mats and corresponding accessories. The table to the right gives information on frames, ramp edges and mat separators and further options are shown in the table below.

Our mat frames can be easily screwed together with corner connectors and are then ready for use. Alternatively, certain frame types can simply be pushed together.

Important ordering information:

1. Type
2. Length (walking direction) = T mm
3. Width (bar length) = B mm
4. Floor recess
5. Screed construction height

Mat separator

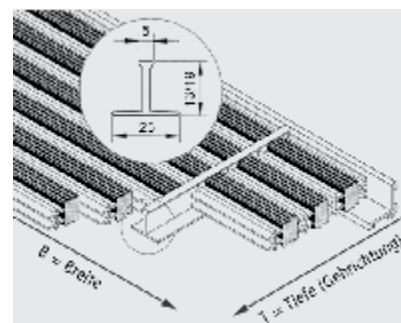

Sketch	Version	Dimensions
	Mat bevels	
	for Portagard	see sketch
	Mat cut-outs	[mm]
	for Portagard	see sketch
	Frame cut-out	[mm]
for Portagard	see sketch	
	Special frame mitres	[mm]
	for Portagard	see sketch
	Sheet steel templates to accurately stiffen frames; for round frames on revolving doors etc. or for complex frame cut-outs or bevels; can be screwed to the frame or frame sections	as per corresponding mat

Overview MAT FRAMES & ACCESSORIES

We manufacture to custom sizes.

Item	Material	Dimensions
Mat frames		[mm]
for Portagard 12 mm	aluminium	15.5 x 25 x 3
for Portagard 12 mm	stainless steel	15 x 25 x 3
for Portagard 17 mm	aluminium	20 x 25 x 3
for Portagard 17 mm	stainless steel	20 x 25 x 3
for Portagard 22 mm	aluminium	25 x 20 x 3
for Portagard 22 mm	stainless steel	25 x 30 x 3
for Portagard 27 mm	aluminium	30 x 20 x 3
for Portagard 27 mm	stainless steel	30 x 25 x 3
Ramp edges		[mm]
for Portagard 17 mm	aluminium	18 x 50 x 2,5



Example image

SUBSTRUCTURES

and dirt collection wells

Allowing trucks or lighter vehicles to drive over entrance areas is becoming increasingly important in highly frequented buildings. This requires substructures in a range of load capacities which can compensate for uneven floors and differences in height.

Bevelling, cut-outs and round edges can be achieved with this design.

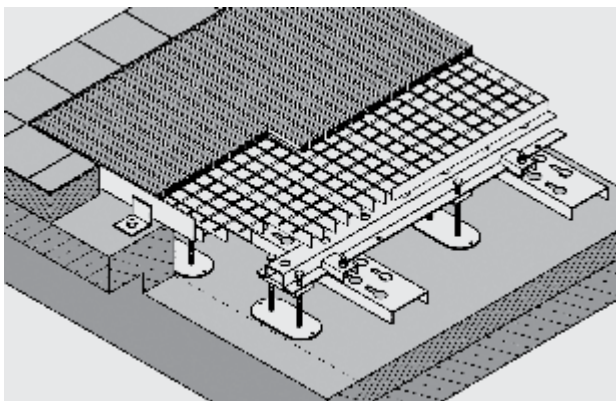

Substructure

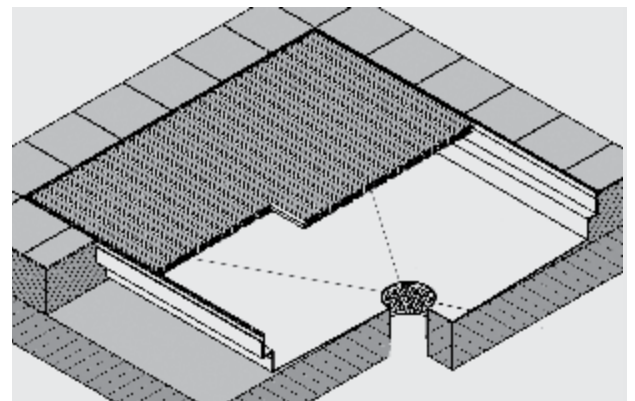

PortaDrain dirt collection well

SUBSTRUCTURES AND DIRT COLLECTION WELLS

Description	Application example	Construction height min/max
Substructure for light and medium loads		[mm]
Substructure for light loadings	Shopping trolleys, handtrolleys	max. 200mm
Substructure for average loadings	Cars, pallet trucks	max 200mm
Substructure for heavy loadings	Delivery vehicles, road sweepers, forklift trucks	max 250mm
Substructure for heavy loadings	Trucks, fire-fighting vehicles, heavy road sweepers	max 250mm
PortaDrain dirt collection well		[mm]
PortaDrain dirt collection well welded watertight	Shopping trolleys, handtrolleys	70mm
Drainage point and sieve		DN 50



PLANNING, MEASURING UP AND INSTALLING

for Kafloor entrance mats

Section sizes, mat partition

The sketches below show the specific points which must be taken into consideration when planning and then laying entrance mats. Sketches or drawings should be submitted for larger mats which show the walking direction and the doors.

Laying sketches are produced from this which are then included with the order confirmation and the subsequent delivery. This ensures the individual sections of the mat are the correct size.

Wherever possible, Kafloor attempts to supply entrance mats as a single piece for aesthetic reasons. Handling considerations restrict the size of a single-piece mat (see table). This makes the individual mat sections easy to handle. The area can be divided into different sized sections on request.

Mat type	Max. single-piece width x length
Portagard 12 mm	3000 mm x 1500 mm; length depending on the type or a maximum mat weight of 25 kg (per piece)
Portagard 17/22/27 mm	3000 mm x 2000 mm; length depending on the type or a maximum mat weight of 30 kg (per piece)

Arrange mat sections like this:

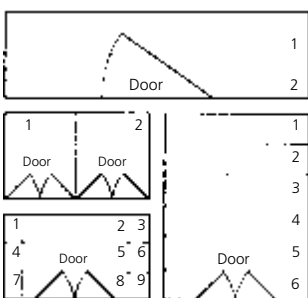

Do not arrange mat sections like this:

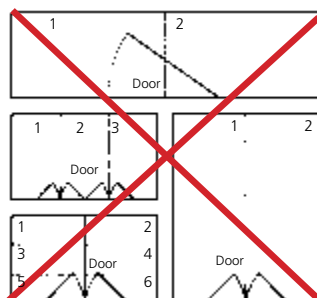

Bevelling and cut-outs

Mat bevelling and cut-outs are carried out in accordance with a corresponding drawing or template. Round frames for revolving doors or complex frame bevelling or cut-outs can be stiffened with sheet steel templates to ensure the frame is laid accurately. The sheet steel templates are screwed into the frame or individual sections of the frame and can then be taken out before laying the mats.

All bevells or cut-outs are calculated from a rectangle or square. Bevells and cut-outs are therefore off-cuts.

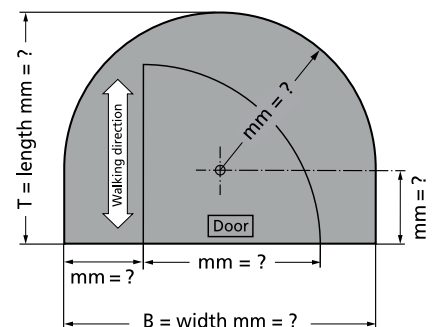
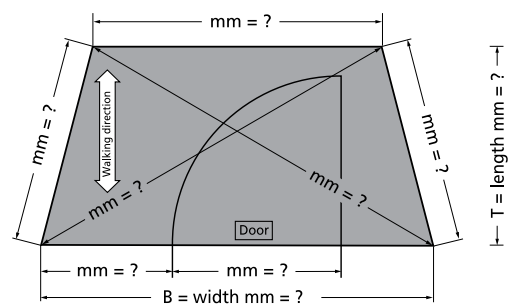
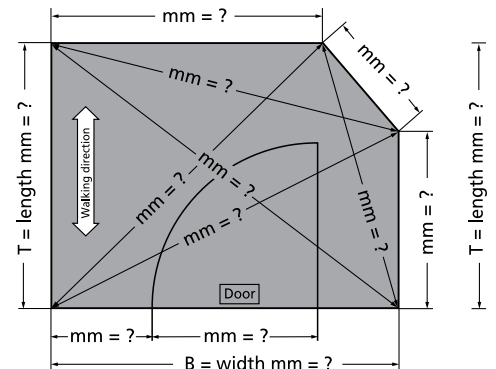



MAINTENANCE

for entrance mats

To ensure the longevity and cleaning performance of the high-quality Kafloor entrance mats, they should be regularly cleaned in accordance with the care instructions provided. How frequently all the care processes described need to be carried out essentially depends on the frequency of use.

1. Daily

Surface dirt should be removed every day with a vacuum cleaner.

2. Weekly

Remove surface dirt with a vacuum cleaner. Remove the mat or mat sections from the frame or recess and thoroughly clean the mat well with a brush or vacuum cleaner. We recommend occasionally turning rigid designs with a usable surface on both sides (this is not possible with cut-outs or asymmetrical designs).

3. Monthly

Complete steps 1. and 2. If there are any obvious areas of heavy contamination, the mat can be treated with a pressure washer with added mild cleaning agents. After every wet clean, place the mat or mat sections upright and leave them to dry. Do not replace them in the mat well until they are dry.





CONTACT

At Kafloor, we expect not only outstanding product quality but an equally high standard of service in the sale process as well. Our internal sales teams can give you all the advice you need for your enquiry and will arrange a professional measuring service for your orders. This quality of service means that even demanding special requests can be accommodated without any problem at all.

In addition to this, our external sales network is available to support you and your projects throughout Europe. Please do not hesitate to contact us at any time!

Kafloor Mats GmbH

Johannes-Gutenberg-Platz 1

06773 Gräfenhainichen

Fax: +49 34953 31-459

email: entrancemats@kafloor.com

Phone: **+49 34953 31-455**

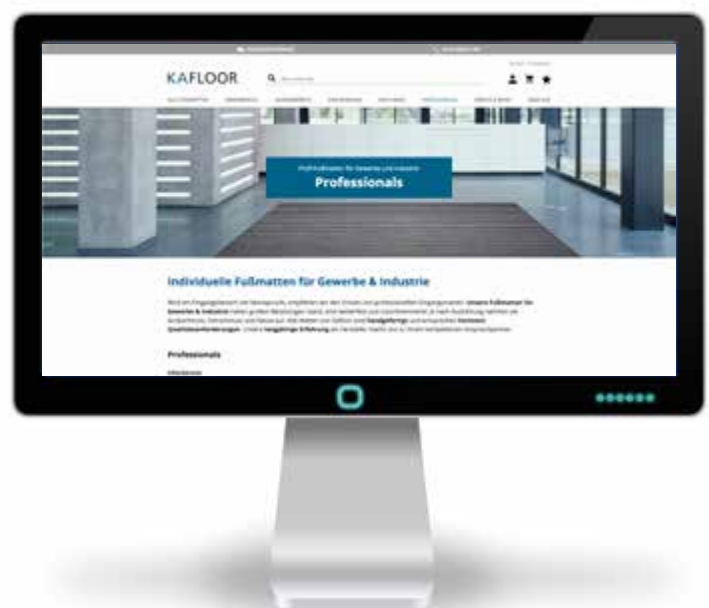

Enquiry **Order** _____

... for construction project _____

Entrance mat without frame

Mat type _____
Frame height _____
Floor recess height _____
Entrance mat width = B [mm] _____
Entrance mat length (walking direction) = T [mm] _____

Order without frame:
The mat dimensions B and T must be 4 mm less than the clear internal dimension of the available floor recess.

Entrance mat with frame

Mat type _____
Frame type _____
Frame external width = RB [mm] _____
Frame external length = RT [mm] _____

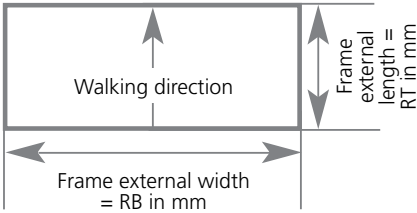

Invoice address

Company: _____
Name _____
Street, no.: _____
Postcode: _____ Town: _____
Phone: _____ Fax: _____
email: _____

Date/Signature: _____

Delivery required by: _____

Please copy and complete this page and fax it to +49 34953 31-459 or send it to entrancemats@kafloor.com.

Kafloor Mats GmbH

Johannes-Gutenberg-Platz 1 06773 Gräfenhainichen
Phone + 49 34953 31455 Fax + 49 34953 31459

entrancemats@kafloor.com
www.kafloor.com